

**PRODUCT** : LCD MODULE**MODEL NO.** : TFT240320-232-E**SUPPLIER** : TRULY SEMICONDUCTORS LTD.**DATE** : July. 18, 2009CERT. No. QAC0946535  
(ISO9001)CERT. No. HKG002005  
(ISO14001)

# SPECIFICATION

Revision: 0.1

**TFT240320-232-E**

This module uses ROHS material

preliminary

If there is no special request from customer, TRULY SEMICONDUCTORS LTD., will not reserve the tooling of the product under the following conditions:

1. There is no response from customer in two years after TRULY SEMICONDUCTORS LTD., submit the samples;
2. There is no order in two years after the latest mass production.

And correlated data (include quality record) will be reserved one year more after tooling was discarded.

**TRULY SEMICONDUCTORS LTD:****CUSTOMER:**Quality Assurance Department: \_\_\_\_\_  
Approved by:

Technical Department: \_\_\_\_\_

Approved by:



# CONTENTS

- GENERAL INFORMATION
- EXTERNAL DIMENSIONS
- ABSOLUTE MAXIMUM RATINGS
- ELECTRICAL CHARACTERISTICS
- ELECTRO-OPTICAL CHARACTERISTICS
- INTERFACE DESCRIPTION
- APPLICATION CIRCUIT
- INITIAL CODE
- RELIABILITY TEST
- INSPECTION CRITERION
- PRECAUTIONS FOR USING LCD MODULES
- USING LCD MODULES
- PRIOR CONSULT MATTER
- FACTORY CONTACT INFORMATION

WRITTEN BY	CHECKED BY	APPROVED BY
YU JI PING	HE SHENG JUN	ZHU JIN BAO

### GENERAL INFORMATION

Item	Contents	Unit
LCD type	TFT/ TRANSFLECTIVE	/
Viewing direction	12:00 O' Clock	6:00O'Clock(Good viewing)
Module area (W × H)	50.00×69.20	mm <sup>2</sup>
Viewing area (W×H)	47.00×60.10	mm <sup>2</sup>
Active area (W×H)	43.20×57.60	mm <sup>2</sup>
Number of Dots	240(RGB0)×320	/
Pixel pitch (W × H)	0.18×0.18	mm <sup>2</sup>
Driver IC	R61505W	/
Colors	262K	/
Backlight Type	LED	/
Module Power consumption	TBD	mw
Interface Type	System parallel interface	/
Input voltage	2.8	V

### EXTERNAL DIMENSIONS

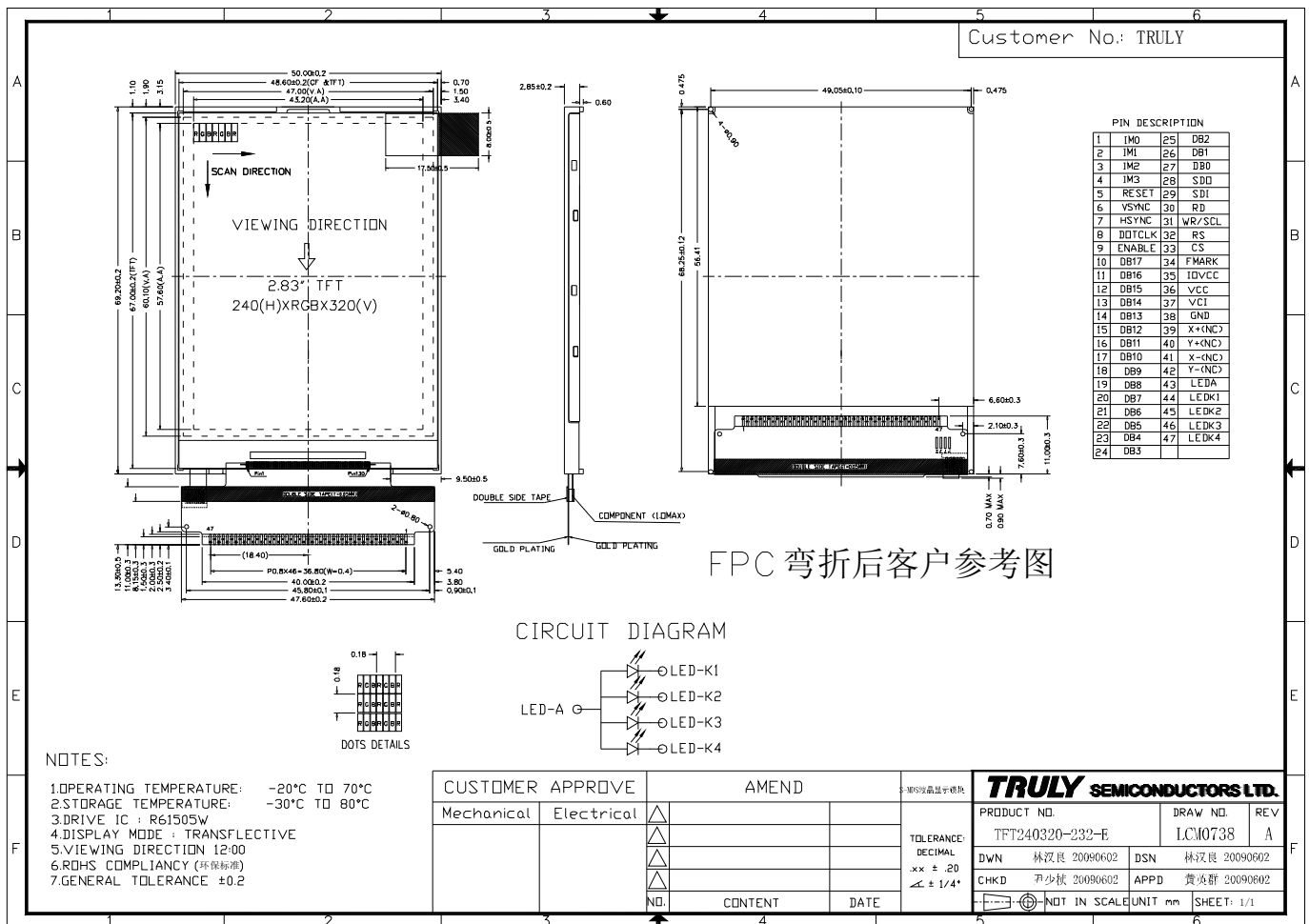

**■ ABSOLUTE MAXIMUM RATINGS**

Parameter	Symbol	Min	Max	Unit
Supply voltage for logic	VCC/VCI/IOVC	-0.3	4.6	V
Input voltage	VIN	-0.3	IUOVcc+0.3	V
Operating temperature	Top	-20	70	°C
Storage temperature	TST	-30	80	°C
Humidity	RH	-	90%(Max60 °C)	RH

**■ ELECTRICAL CHARACTERISTICS**

## DC CHARACTERISTICS

Parameter	Symbol	Min	Typ	Max	Unit
Supply voltage for logic	VDD-VSS	2.7	2.8	2.9	V
I/O power supply	IOVCC	1.7/2.7	1.8/2.8	1.9/2.9	V
Input Current	I <sub>dd</sub>	-	TBD	TBD	mA
Input voltage 'H' level	V <sub>IH</sub>	0.8IOVcc	-	IOVcc	V
Input voltage 'L' level	V <sub>IL</sub>	-0.3	-	0.2IOVcc	V
Output voltage 'H' level	V <sub>OH</sub>	0.8IOVcc	-	-	V
Output voltage 'L' level	V <sub>OL</sub>	-	-	0.2IOVcc	V

**■ TIMING OF POWER SUPPLY**

PLEASE REFER TO THE DRIVER IC SPECIFICATION.

**■ BACKLIGHT CHARACTERISTICS**

Item	Symbol	Min.	Typ.	Max.	Unit	Condition
Forward voltage	V <sub>f</sub>	2.9	3.2	3.4	V	I <sub>f</sub> =60mA
Luminance	L <sub>v</sub>	3500	3900	4300	cd/m <sup>2</sup>	
Number of LED	4	-	-	-	Piece	-
Connection mode	P	-	Parallel	-	-	-

Using condition: constant current driving method I<sub>f</sub>=60mA (+/-10%).

## ■ELECTRO-OPTICAL CHARACTERISTICS

Item	Symbol	Condition	Min	Typ	Max	Unit	Remark	Note
Response time	Tr +Tf	θ=0° ∅=0° Ta=25 °C	-	TBD	TBD	ms	FIG 1.	4
Contrast ratio	Cr		TBD	TBD	-	---	FIG 2.	1
Luminance uniformity	δ WHITE		TBD	TBD	-	%	FIG 2.	3
Surface Luminance	Lv		TBD	TBD	-	cd/m <sup>2</sup>	FIG 2.	2
Viewing angle range	θ	∅ = 90°	TBD	TBD	-	deg	FIG 3.	6
		∅ = 270°	TBD	TBD	-	deg	FIG 3.	
		∅ = 0°	TBD	TBD	-	deg	FIG 3.	
		∅ = 180°	TBD	TBD	-	deg	FIG 3.	
CIE (x, y) chromaticity	Red x	θ=0° ∅=0° Ta=25 °C	TBD	TBD	TBD	-	FIG 2.	5
	Red y		TBD	TBD	TBD			
	Green x		TBD	TBD	TBD			
	Green y		TBD	TBD	TBD			
	Blue x		TBD	TBD	TBD			
	Blue y		TBD	TBD	TBD			
	White x		TBD	TBD	TBD			
	White y		TBD	TBD	TBD			

Note 1. Contrast Ratio(CR) is defined mathematically as For more information see FIG 2.:

$$\text{Contrast Ratio} = \frac{\text{Average Surface Luminance with all white pixels (P}_1, \text{P}_2, \text{P}_3, \text{P}_4, \text{P}_5)}{\text{Average Surface Luminance with all black pixels (P}_1, \text{P}_2, \text{P}_3, \text{P}_4, \text{P}_5)}$$

Note 2. Surface luminance is the LCD surface from the surface with all pixels displaying white. For more information see FIG 2.

$$L_v = \text{Average Surface Luminance with all white pixels (P}_1, \text{P}_2, \text{P}_3, \text{P}_4, \text{P}_5)$$

Note 3. The uniformity in surface luminance, δ WHITE is determined by measuring luminance at each test position 1 through 5, and then dividing the maximum luminance of 5 points luminance by minimum luminance of 5 points luminance. For more information see FIG 2.

$$\delta \text{ WHITE} = \frac{\text{Minimum Surface Luminance with all white pixels (P}_1, \text{P}_2, \text{P}_3, \text{P}_4, \text{P}_5)}{\text{Maximum Surface Luminance with all white pixels (P}_1, \text{P}_2, \text{P}_3, \text{P}_4, \text{P}_5)}$$

Note 4. Response time is the time required for the display to transition from White to black(Rise Time, Tr) and from black to white(Decay Time, Tf). For additional information see FIG 1. The test equipment is Autronic-Melchers's ConoScope. Series

Note 5. CIE (x, y) chromaticity, The x,y value is determined by measuring luminance at each test position 1 through 5, and then make average value

Note 6. Viewing angle is the angle at which the contrast ratio is greater than 2. For TFT module the contrast ratio is greater than 10. The angles are determined for the horizontal or x axis and the vertical or y axis with respect to the z axis which is normal to the LCD surface. For more information see FIG 3.

Note 7. For Viewing angle and response time testing, the testing data is base on Autronic-Melchers's ConoScope. Series Instruments. For contrast ratio, Surface Luminance, Luminance uniformity, CIE The test data is base on TOPCON's BM-5 photo detector.

Note 8. For Transflective or Reflective mode, Reflectivity should be tested. The test data is base on DMS-803. For more information see FIG 4.

FIG.1. The definition of Response Time

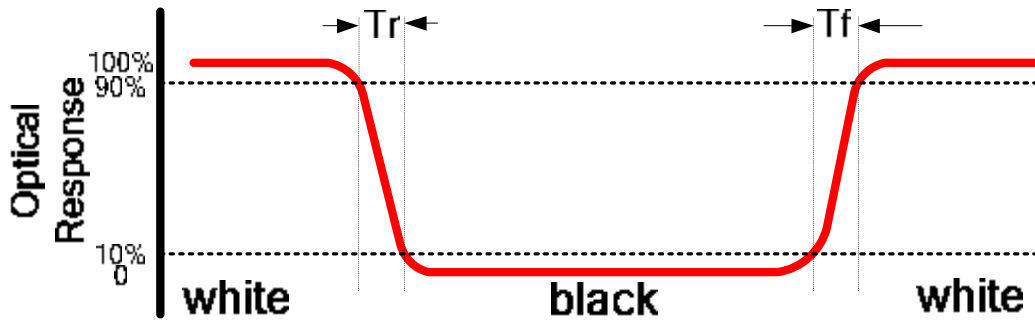

FIG.2. Measuring method for Contrast ratio, surface luminance, Luminance uniformity, CIE (x, y) chromaticity

A : 5 mm  
 B : 5 mm  
 H, V : Active Area  
 Light spot size  $\varnothing=5\text{mm}$ , 500mm distance from the LCD surface to detector lens  
 measurement instrument is TOPCON's luminance meter BM-5

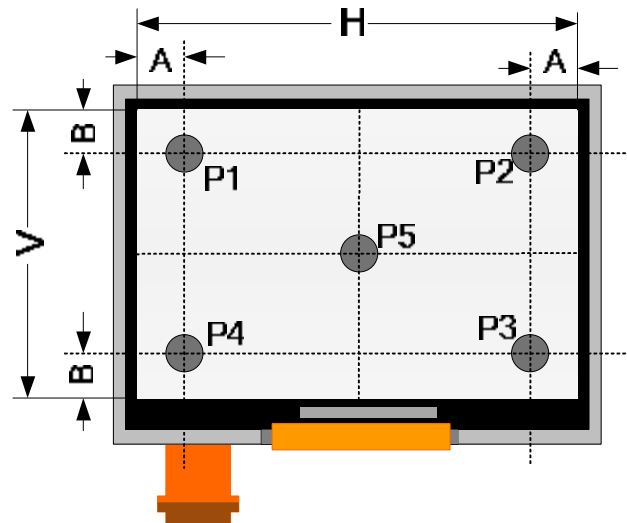
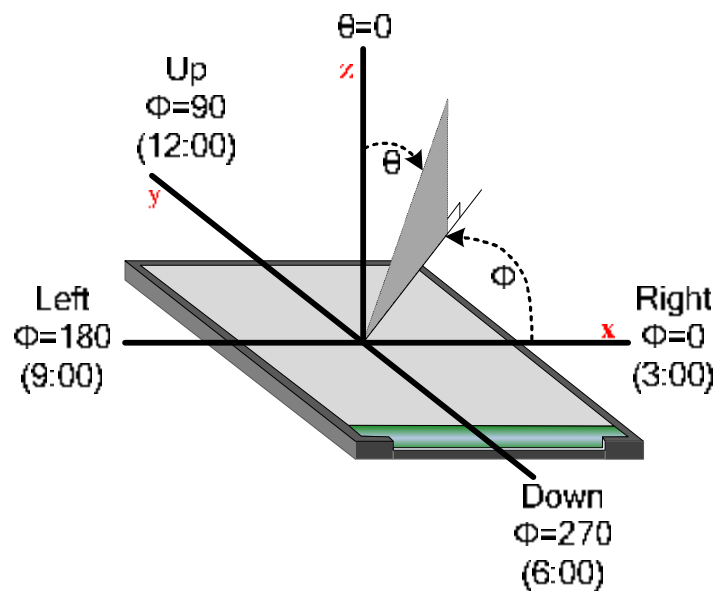
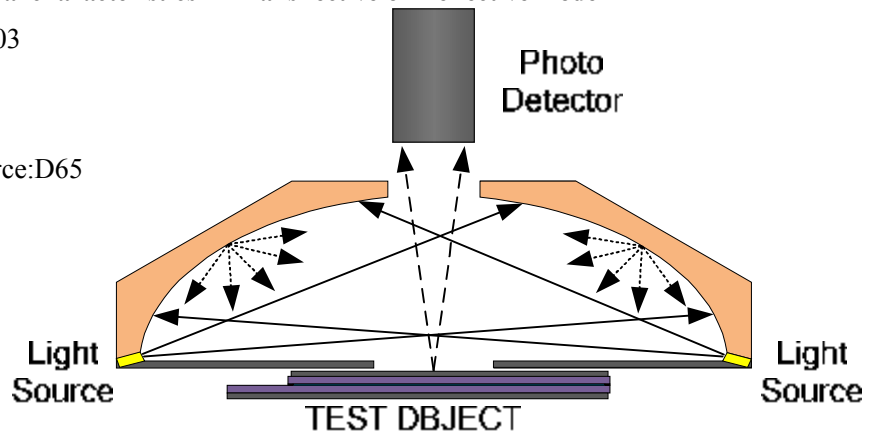

FIG.3. The definition of viewing angle



**FIG.4. Measuring method for optical characteristics in Transflective or Reflective mode**

Device: Autroic-Melchers DMS-803  
 Light source: DMS hemisphere  
 Detector angle : $\theta=0$   
 Detector position: Screen center  
 Spectrometer evaluation light source: D65



**■ INTERFACE DESCRIPTION**

Interface NO.	Symbol	I/O or connect to	Description	when not in use
1	IM0	I	Select a mode to interface to host processor. (Amplitude: IOVCC ~GND), Refer TO NOTE1	-
2	IM1			-
3	IM2			-
4	IM3			-
5	RESET	I	Reset signal, low active	-
6	VSYNC	I	Frame synchronizing signal.	IOVCC
7	HSYNC	I	Frame synchronizing signal.	IOVCC
8	DOTCLK	I	Dot clock signal.	GND
9	ENABLE	I	Data enable signal for RGB interface operation. (Amplitude: IOVCC-GND). Low: accessible (select) High: Not accessible (Not select) The polarity of ENABLE signal can be inverted by setting the EPL bit. (Amplitude: IOVCC-GND).	GND/IO VCC
10	DB17	I/O	18-bit parallel bi-directional data bus for 80-system interface operation (Amplitude: IOVCC-GND). 8-bit I/F: DB[17:10] are used. 9-bit I/F: DB[17:9] are used. 16-bit I/F: DB[17:10] and DB[8:1] are used. 18-bit I/F: DB[17:0] are used. 18-bit parallel bi-directional data bus for RGB interface operation (Amplitude: IOVCC-GND). 16-bit I/F: DB[17:13] and DB[11:1] are used. 18-bit I/F: DB[17:0] are used.	GND/IO VCC
11	DB16			
12	DB15			
13	DB14			
14	DB13			
15	DB12			
16	DB11			
17	DB10			
18	DB9			
19	DB8			
20	DB7			
21	DB6			
22	DB5			
23	DB4			
24	DB3			
25	DB2			

26	DB1			
27	DB0			
28	SDO	O	Serial data output (SDO) pin in serial interface operation. The data is outputted on the falling edge of the SCL signal. Amplitude: IOVCC-GND	OPEN
29	SDI	I	Serial data input (SDI) pin in serial interface operation. The data is inputted on the rising edge of the SCL signal. Amplitude: IOVCCGND	GND/IO VCC
30	RD	I	Read strobe signal in 80-system bus interface operation and enables read operation when RDX is low. Amplitude: IOVCC-GND	IOVCC
31	WR/SCL	I	Write strobe signal in 80-system bus interface operation and enables write operation when WRX is low. Synchronous clock signal (SCL) in serial interface operation. Amplitude: IOVCC-GND	IOVCC
32	RS	I	Register select signal. Amplitude: IOVCC-GND Low: select Index register High: select control register	IOVCC
33	CS	I	Chip select signal. Amplitude: IOVCC-GND Low: the R61505W is selected and accessible High: the R61505W is not selected and not accessible	IOVCC
34	FMARK	O	Frame head pulse signal, which is used when writing data to the internal frame memory. (Amplitude: IOVCC-GND).	OPEN
35	IOVCC	-	interface voltage	-
36	VCC	-	Logic regulator power supply.	-
37	VCI	I	liquid crystal drive power supply voltage	-
38	GND	-	POWER GROUND	-
39	Y(u)	NC	NO CONNECT	-
40	X(L)	NC	NO CONNECT	-
41	Y(D)	NC	NO CONNECT	-
42	X(R)	NC	NO CONNECT	-
43	LEDA	LED driver	LED ANODE	-
44	LEDK1	LED driver	LED CATHODE	-
45	LEDK2	LED driver	LED CATHODE	-
46	LEDK3	LED driver	LED CATHODE	-
47	LEDK4	LED driver	LED CATHODE	-

**■ APPLICATION CIRCUIT**

Please consult our technical department for detail information.

**■ INITIAL CODE**

Please consult our technical department for detail information.

**■ RELIABILITY TEST**

No.	Test Item	Test Condition	Inspection after test
1	High Temperature Storage	80±2°C/200 hours	Inspection after 2~4hours storage at room temperature, the sample shall be free from defects: 1.Air bubble in the LCD; 2.Sealleak; 3.Non-display; 4.missing segments; 5.Glass crack; 6.Current Idd is twice higher than initial value.
2	Low Temperature Storage	-30±2°C/200 hours	
3	High Temperature Operating	70±2°C/120 hours	
4	Low Temperature Operating	-20±2°C/120 hours	
5	Temperature Cycle	-20±2°C~25~70±2°C×10cycles (30min.) (5min.) (30min.)	
6	Damp Proof Test	50°C±5°C×90%RH/120 hours	
7	Vibration Test	Frequency: 10Hz~55Hz~10Hz Amplitude: 1.5mm, X, Y, Z direction for total 3hours (Packing condition)	
8	Dropping test	Drop to the ground from 1m height, one time, every side of carton. (Packing condition)	
9	ESD test	Voltage:±8KV R: 330Ω C: 150pF Air discharge, 10time	

**Remark:**

- 1.The test samples should be applied to only one test item.
- 2.Sample size for each test item is 5~10pcs.
- 3.For Damp Proof Test, Pure water(Resistance> 10MΩ) should be used.
- 4.In case of malfunction defect caused by ESD damage, if it would be recovered to normal state after resetting, it would be judge as a good part.  
Using ionizer(an antistatic blower) is recommended at working area in order to reduce electro-static voltage.  
When removing protection film from LCM panel, peel off the tag slowly( recommended more than one second) while blowing with ionizer toward the peeling face to minimize ESD which may damage electrical circuit.
- 5.EL evaluation should be excepted from reliability test with humidity and temperature: Some defects such as black spot/blemish can happen by natural chemical reaction with humidity and Fluorescence EL has.
- 6.Please use automatic switch menu(or roll menu) testing mode when test operating mode

**■ INSPECTION CRITERION****TRULY**<sup>®</sup> OUTGOING QUALITY STANDARD

PAGE 1 OF 4

TITLE:FUNCTIONAL TEST &amp; INSPECTION CRITERIA

MDS Product

This specification is made to be used as the standard acceptance/rejection criteria for Color mobile phone LCM.

**1 Sample plan**

Sampling plan according to GB/T2828.1-2003/ISO 2859-1: 1999 and ANSI/ASQC Z1.4-1993, normal level 2 and based on:

Major defect: AQL 0.65

Minor defect: AQL 1.5

**2. Inspection condition**

Viewing distance for cosmetic inspection is about 30cm with bare eyes, and under an environment of 20~40W light intensity, all directions for inspecting the sample should be within 45° against perpendicular line.

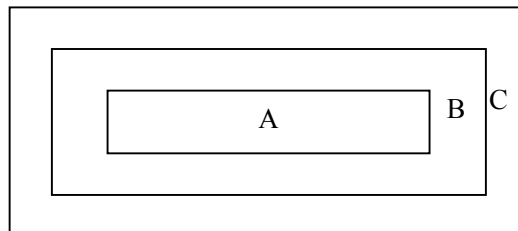
**3. Definition of inspection zone in LCD.**

Zone A: character/Digit area

Zone B: viewing area except Zone A (ZoneA+ZoneB=minimum Viewing area)

Zone C: Outside viewing area (invisible area after assembly in customer's product)

Fig.1 Inspection zones in an LCD.

Note: As a general rule, visual defects in Zone C are permissible, when it is no trouble for quality and assembly of customer's product.

<b>TRULY®</b> OUTGOING QUALITY STANDARD	PAGE 2 OF 4
TITLE:FUNCTIONAL TEST & INSPECTION CRITERIA	MDS Product

**4. Inspection standards**

**4.1 Major Defect**

Item No	Items to be inspected	Inspection Standard	Classification of defects
4.1.1	All functional defects	1) No display 2) Display abnormally 3) Missing vertical, horizontal segment 4) Short circuit 5) Back-light no lighting, flickering and abnormal lighting.	Major
4.1.2	Missing	Missing component	
4.1.3	Outline dimension	Overall outline dimension beyond the drawing is not allowed.	

**4.2 Cosmetic Defect**

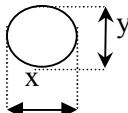
Item No	Items to be inspected	Inspection Standard	Classification of defects																										
4.2.1	Clear Spots	For dark/white spot, size $\Phi$ is defined as $\Phi = \frac{(x+y)}{2}$ 	Minor																										
	Black and white Spot defect Pinhole, Foreign Particle, Dirt under polarizer	1. <table border="1" style="width: 100%; border-collapse: collapse;"> <thead> <tr> <th rowspan="2">Size(mm) \ Zone</th> <th colspan="3">Acceptable Qty</th> </tr> <tr> <th>A</th> <th>B</th> <th>C</th> </tr> </thead> <tbody> <tr> <td><math>\Phi \leq 0.15</math></td> <td colspan="3" style="text-align: center;">Ignore</td> </tr> <tr> <td><math>0.15 &lt; \Phi \leq 0.2</math></td> <td colspan="3" style="text-align: center;">3</td> </tr> <tr> <td><math>0.2 &lt; \Phi \leq 0.25</math></td> <td colspan="3" style="text-align: center;">1</td> </tr> <tr> <td><math>\Phi &gt; 0.25</math></td> <td colspan="3" style="text-align: center;">0</td> </tr> </tbody> </table>		Size(mm) \ Zone	Acceptable Qty			A	B	C	$\Phi \leq 0.15$	Ignore			$0.15 < \Phi \leq 0.2$	3			$0.2 < \Phi \leq 0.25$	1			$\Phi > 0.25$	0					
Size(mm) \ Zone	Acceptable Qty																												
	A	B	C																										
$\Phi \leq 0.15$	Ignore																												
$0.15 < \Phi \leq 0.2$	3																												
$0.2 < \Phi \leq 0.25$	1																												
$\Phi > 0.25$	0																												
	Dim Spots	2.	Minor																										
	Circle shaped and dim edged defects	<table border="1" style="width: 100%; border-collapse: collapse;"> <thead> <tr> <th rowspan="2">2. Zone Size(mm)</th> <th colspan="3">Acceptable Qty</th> </tr> <tr> <th>A</th> <th>B</th> <th>C</th> </tr> </thead> <tbody> <tr> <td><math>\Phi \leq 0.2</math></td> <td colspan="3" style="text-align: center;">Ignore</td> </tr> <tr> <td><math>0.20 &lt; \Phi \leq 0.60</math></td> <td colspan="3" style="text-align: center;">4</td> </tr> <tr> <td><math>0.60 &lt; \Phi \leq 0.80</math></td> <td colspan="3" style="text-align: center;">2</td> </tr> <tr> <td><math>0.80 &lt; \Phi \leq 1.0</math></td> <td colspan="3" style="text-align: center;">1</td> </tr> <tr> <td><math>1.0 &lt; \Phi</math></td> <td colspan="3" style="text-align: center;">0</td> </tr> </tbody> </table>		2. Zone Size(mm)	Acceptable Qty			A	B	C	$\Phi \leq 0.2$	Ignore			$0.20 < \Phi \leq 0.60$	4			$0.60 < \Phi \leq 0.80$	2			$0.80 < \Phi \leq 1.0$	1			$1.0 < \Phi$	0	
2. Zone Size(mm)	Acceptable Qty																												
	A	B	C																										
$\Phi \leq 0.2$	Ignore																												
$0.20 < \Phi \leq 0.60$	4																												
$0.60 < \Phi \leq 0.80$	2																												
$0.80 < \Phi \leq 1.0$	1																												
$1.0 < \Phi$	0																												

<b>TRULY</b> ® OUTGOING QUALITY STANDARD	PAGE 3 OF 4
--	-------------

TITLE: FUNCTIONAL TEST & INSPECTION CRITERIA	MDS Product
--	-------------

4.2. Cosmetic Defect

Item No	Items to be inspected	Inspection Standard	Classification of defects																																	
4.2.2	Line defect Black line, White line, Foreign material under polarizer,	<table border="1" style="width:100%; border-collapse: collapse;"> <thead> <tr> <th colspan="2">Size(mm)</th> <th colspan="3">Acceptable Qty</th> </tr> <tr> <th rowspan="2">L(Length)</th> <th rowspan="2">W(Width)</th> <th colspan="3">Zone</th> </tr> <tr> <th>A</th> <th>B</th> <th>C</th> </tr> </thead> <tbody> <tr> <td>Ignore</td> <td><math>W \leq 0.02</math></td> <td colspan="3">Ignore</td> </tr> <tr> <td><math>L \leq 3.0</math></td> <td><math>0.02 &lt; W \leq 0.03</math></td> <td colspan="3">2</td> </tr> <tr> <td><math>L \leq 2.0</math></td> <td><math>0.03 &lt; W \leq 0.05</math></td> <td colspan="3">1</td> </tr> <tr> <td></td> <td><math>0.05 &lt; W</math></td> <td colspan="3">Define as spot defect</td> </tr> </tbody> </table>	Size(mm)		Acceptable Qty			L(Length)	W(Width)	Zone			A	B	C	Ignore	$W \leq 0.02$	Ignore			$L \leq 3.0$	$0.02 < W \leq 0.03$	2			$L \leq 2.0$	$0.03 < W \leq 0.05$	1				$0.05 < W$	Define as spot defect			Minor
Size(mm)		Acceptable Qty																																		
L(Length)	W(Width)	Zone																																		
		A	B	C																																
Ignore	$W \leq 0.02$	Ignore																																		
$L \leq 3.0$	$0.02 < W \leq 0.03$	2																																		
$L \leq 2.0$	$0.03 < W \leq 0.05$	1																																		
	$0.05 < W$	Define as spot defect																																		
4.2.3	Polarizer scratch	<p>If the Polarizer scratch can be seen after mobile phone cover assembling or in the operating condition, judge by the line defect of 4.2.2.</p> <p>If the Polarizer scratch can be seen only in non-operating condition or some special angle, judge by the following.</p> <table border="1" style="width:100%; border-collapse: collapse;"> <thead> <tr> <th colspan="2">Size(mm)</th> <th colspan="3">Acceptable Qty</th> </tr> <tr> <th rowspan="2">L(Length)</th> <th rowspan="2">W(Width)</th> <th colspan="3">Zone</th> </tr> <tr> <th>A</th> <th>B</th> <th>C</th> </tr> </thead> <tbody> <tr> <td>Ignore</td> <td><math>W \leq 0.03</math></td> <td colspan="3">Ignore</td> </tr> <tr> <td><math>5.0 &lt; L \leq 10.0</math></td> <td><math>0.03 &lt; W \leq 0.05</math></td> <td colspan="3">2</td> </tr> <tr> <td><math>L \leq 5.0</math></td> <td><math>0.05 &lt; W \leq 0.08</math></td> <td colspan="3">1</td> </tr> <tr> <td></td> <td><math>0.08 &lt; W</math></td> <td colspan="3">0</td> </tr> </tbody> </table>	Size(mm)		Acceptable Qty			L(Length)	W(Width)	Zone			A	B	C	Ignore	$W \leq 0.03$	Ignore			$5.0 < L \leq 10.0$	$0.03 < W \leq 0.05$	2			$L \leq 5.0$	$0.05 < W \leq 0.08$	1				$0.08 < W$	0			Minor
Size(mm)		Acceptable Qty																																		
L(Length)	W(Width)	Zone																																		
		A	B	C																																
Ignore	$W \leq 0.03$	Ignore																																		
$5.0 < L \leq 10.0$	$0.03 < W \leq 0.05$	2																																		
$L \leq 5.0$	$0.05 < W \leq 0.08$	1																																		
	$0.08 < W$	0																																		
4.2.4	Polarize Air bubble	<p>Air bubbles between glass &amp; polarizer</p> <table border="1" style="width:100%; border-collapse: collapse;"> <thead> <tr> <th rowspan="2">Size(mm) 2. Zone</th> <th colspan="3">Acceptable Qty</th> </tr> <tr> <th>A</th> <th>B</th> <th>C</th> </tr> </thead> <tbody> <tr> <td><math>\Phi \leq 0.2</math></td> <td colspan="3">Ignore</td> </tr> <tr> <td><math>0.20 &lt; \Phi \leq 0.30</math></td> <td colspan="3">2</td> </tr> <tr> <td><math>0.30 &lt; \Phi \leq 0.50</math></td> <td colspan="3">1</td> </tr> <tr> <td><math>0.50 &lt; \Phi</math></td> <td colspan="3">0</td> </tr> </tbody> </table>	Size(mm) 2. Zone	Acceptable Qty			A	B	C	$\Phi \leq 0.2$	Ignore			$0.20 < \Phi \leq 0.30$	2			$0.30 < \Phi \leq 0.50$	1			$0.50 < \Phi$	0			Minor										
Size(mm) 2. Zone	Acceptable Qty																																			
	A	B	C																																	
$\Phi \leq 0.2$	Ignore																																			
$0.20 < \Phi \leq 0.30$	2																																			
$0.30 < \Phi \leq 0.50$	1																																			
$0.50 < \Phi$	0																																			

<b>TRULY</b> ® OUTGOING QUALITY STANDARD	PAGE 4 OF 4
--	-------------

TITLE:FUNCTIONAL TEST & INSPECTION CRITERIA	MDS Product
---	-------------

4.3. Cosmetic Defect

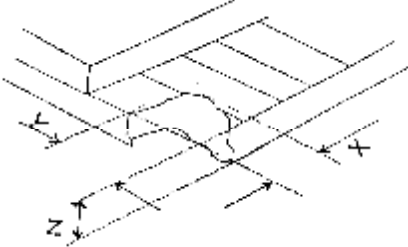
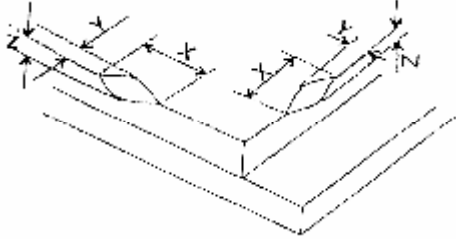
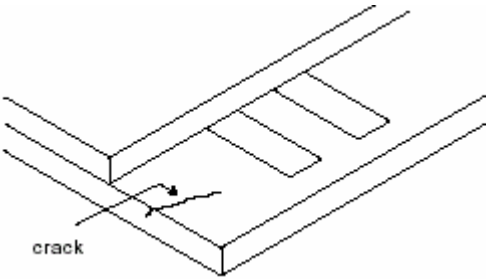
Item No	Items to be inspected	Inspection Standard	Classification of defects						
4.3.5	Glass defect	(i) Chips on corner  <table border="1" style="margin: 10px auto;"> <tr> <td style="text-align: center;">X</td> <td style="text-align: center;">Y</td> <td style="text-align: center;">Z</td> </tr> <tr> <td style="text-align: center;">≤2.0</td> <td style="text-align: center;">≤S</td> <td style="text-align: center;">Disregard</td> </tr> </table> <p>Notes: S=contact pad length Chips on the corner of terminal shall not be allowed to extend into the ITO pad or expose perimeter seal.</p>	X	Y	Z	≤2.0	≤S	Disregard	Minor
		X	Y	Z					
		≤2.0	≤S	Disregard					
(ii) Usual surface cracks  <table border="1" style="margin: 10px auto;"> <tr> <td style="text-align: center;">X</td> <td style="text-align: center;">Y</td> <td style="text-align: center;">Z</td> </tr> <tr> <td style="text-align: center;">≤3.0</td> <td style="text-align: center;">&lt;Inner border line of the seal</td> <td style="text-align: center;">Disregard</td> </tr> </table>	X	Y	Z	≤3.0	<Inner border line of the seal	Disregard	Minor		
X	Y	Z							
≤3.0	<Inner border line of the seal	Disregard							
(iii) Crack Cracks tend to break are not allowed. 	Major								
4.3.6	Parts alignment	1) Not allow IC and FPC/heat-seal lead width is more than 50% beyond lead pattern. 2) Not allow chip or solder component is off center more than 50% of the pad outline.	Minor						
4.3.7	SMT	According to the <Acceptability of electronic assemblies> IPC-A-610C class 2 standard. Component missing or function defect are Major defect, the others are Minor defect.							

## ■ PRECAUTIONS FOR USING LCD MODULES

### Handling Precautions

- 1) The display panel is made of glass and polarizer. As glass is fragile. It tends to become or chipped during handling especially on the edges. Please avoid dropping or jarring. Do not subject it to a mechanical shock by dropping it or impact.
- 2) If the display panel is damaged and the liquid crystal substance leaks out, be sure not to get any in your mouth. If the substance contacts your skin or clothes, wash it off using soap and water.
- 3) Do not apply excessive force to the display surface or the adjoining areas since this may cause the color tone to vary. Do not touch the display with bare hands. This will stain the display area and degraded insulation between terminals (some cosmetics are determined to the polarizer).
- 4) The polarizer covering the display surface of the LCD module is soft and easily scratched. Handle this polarizer carefully. Do not touch, push or rub the exposed polarizers with anything harder than an HB pencil lead (glass, tweezers, etc.). Do not put or attach anything on the display area to avoid leaving marks on. Condensation on the surface and contact with terminals due to cold will damage, stain or dirty the polarizer. After products are tested at low temperature they must be warmed up in a container before coming is contacting with room temperature air.
- 5) If the display surface becomes contaminated, breathe on the surface and gently wipe it with a soft dry cloth. If it is heavily contaminated, moisten cloth with one of the following solvents
  - Isopropyl alcohol
  - Ethyl alcoholDo not scrub hard to avoid damaging the display surface.
- 6) Solvents other than those above-mentioned may damage the polarizer. Especially, do not use the following.
  - Water
  - Ketone
  - Aromatic solventsWipe off saliva or water drops immediately, contact with water over a long period of time may cause deformation or color fading. Avoid contacting oil and fats.
- 7) Exercise care to minimize corrosion of the electrode. Corrosion of the electrodes is accelerated by water droplets, moisture condensation or a current flow in a high-humidity environment.
- 8) Install the LCD Module by using the mounting holes. When mounting the LCD module make sure it is free of twisting, warping and distortion. In particular, do not forcibly pull or bend the I/O cable or the backlight cable.
- 9) Do not attempt to disassemble or process the LCD module.
- 10) NC terminal should be open. Do not connect anything.
- 11) If the logic circuit power is off, do not apply the input signals.
- 12) Electro-Static Discharge Control, Since this module uses a CMOS LSI, the same careful attention should be paid to electrostatic discharge as for an ordinary CMOS IC. To prevent destruction of the elements by static electricity, be careful to maintain an optimum work environment.
  - Before remove LCM from its packing case or incorporating it into a set, be sure the module and your body have the same electric potential. Be sure to ground the body when handling the LCD modules.
  - Tools required for assembling, such as soldering irons, must be properly grounded. make certain the AC power source for the soldering iron does not leak. When using an electric screwdriver to attach LCM, the screwdriver should be of ground potentiality to minimize as much as possible any transmission of electromagnetic waves produced sparks coming from the commutator of the motor.
  - To reduce the amount of static electricity generated, do not conduct assembling and other work under dry conditions. To reduce the generation of static electricity be careful that the air in the work is not too dried. A relative humidity of 50%-60% is recommended. As far as possible make the electric potential of your work clothes and that of the work bench the ground potential
  - The LCD module is coated with a film to protect the display surface. Exercise care when peeling off this protective film since static electricity may be generated
- 13) Since LCM has been assembled and adjusted with a high degree of precision, avoid applying excessive shocks to the module or making any alterations or modifications to it.
  - Do not alter, modify or change the shape of the tab on the metal frame.
  - Do not make extra holes on the printed circuit board, modify its shape or change the positions of components to be attached.
  - Do not damage or modify the pattern writing on the printed circuit board.
  - Absolutely do not modify the zebra rubber strip (conductive rubber) or heat seal connector.
  - Except for soldering the interface, do not make any alterations or modifications with a soldering iron.
  - Do not drop, bend or twist LCM.

**Handling precaution for LCM**

LCM is easy to be damaged. Please note below and be careful for handling.

**Correct handling:**

As above picture, please handle with anti-static gloves around LCM edges.

**Incorrect handling:**

Please don't touch IC directly.

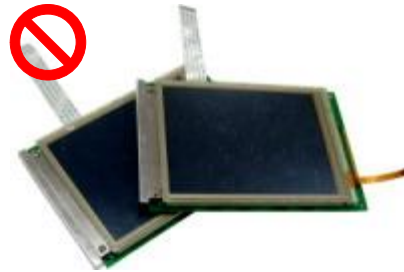

Please don't stack LCM.



Please don't hold the surface of panel.

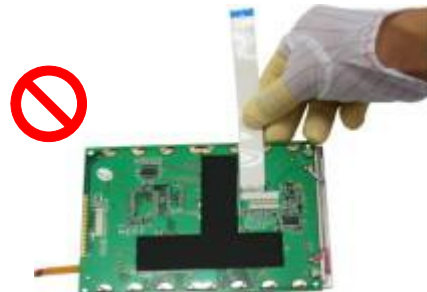

Please don't stretch interface of output, such as FPC cable.

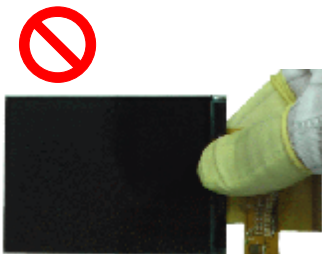

Please don't hold the surface of IC.

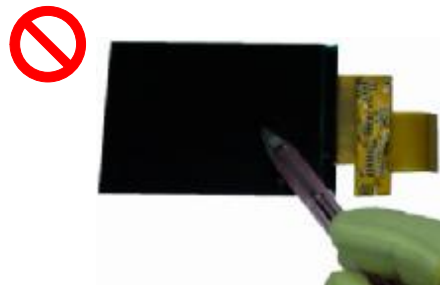

Please don't operate with sharp stick such as pens.

**Storage Precautions**

When storing the LCD modules, the following precaution is necessary.

- 1) Store them in a sealed polyethylene bag. If properly sealed, there is no need for the dessicant.
- 2) Store them in a dark place. Do not expose to sunlight or fluorescent light, keep the temperature between 0°C and 35°C, and keep the relative humidity between 40%RH and 60%RH.
- 3) The polarizer surface should not come in contact with any other objects. (We advise you to store them in the anti-static electricity container in which they were shipped.

**Others**

Liquid crystals solidify under low temperature (below the storage temperature range) leading to defective orientation or the generation of air bubbles (black or white). Air bubbles may also be generated if the module is subject to a low temperature.

If the LCD modules have been operating for a long time showing the same display patterns, the display patterns may remain on the screen as ghost images and a slight contrast irregularity may also appear. A normal operating status can be regained by suspending use for some time. It should be noted that this phenomenon does not adversely affect performance reliability.

To minimize the performance degradation of the LCD modules resulting from destruction caused by static electricity etc., exercise care to avoid holding the following sections when handling the modules.

- Exposed area of the printed circuit board.
- Terminal electrode sections.

■ USING LCD MODULES

**Installing LCD Modules**

The hole in the printed circuit board is used to fix LCM as shown in the picture below. Attend to the following items when installing the LCM.

- 1) Cover the surface with a transparent protective plate to protect the polarizer and LC cell.

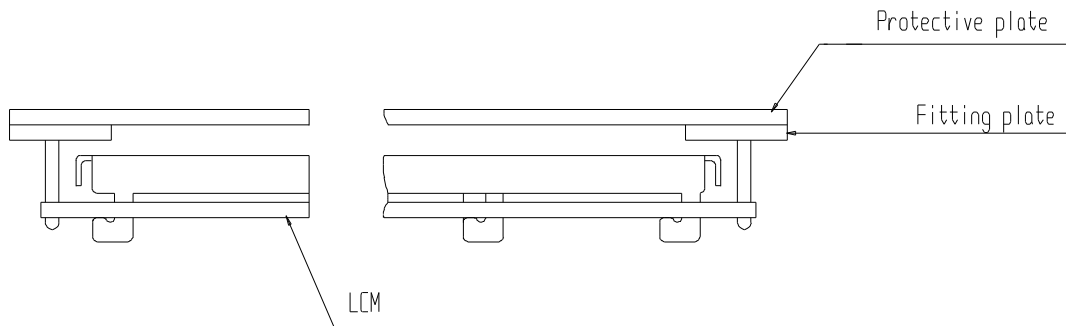

- 2) When assembling the LCM into other equipment, the spacer to the bit between the LCM and the fitting plate should have enough height to avoid causing stress to the module surface, refer to the individual specifications for measurements. The measurement tolerance should be  $\pm 0.1$  mm.

**Precaution for assemble the module with BTB connector:**

Please note the position of the male and female connector position, don't assemble or assemble like the method which the following picture shows

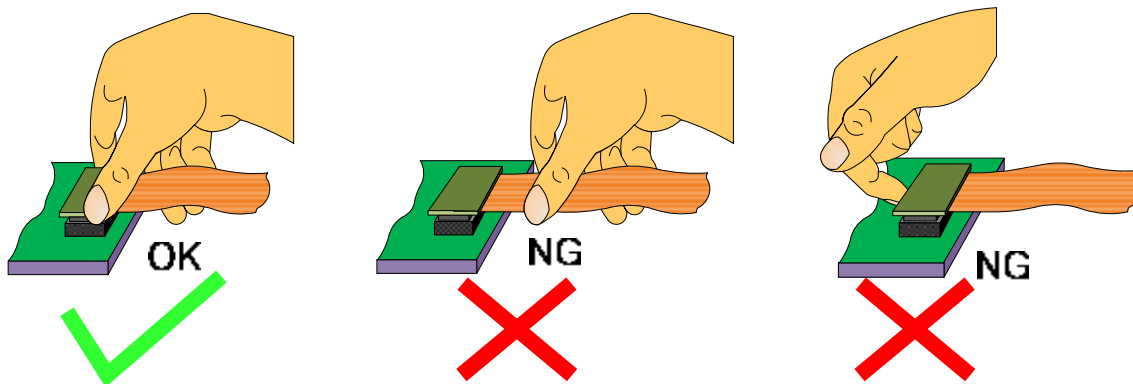
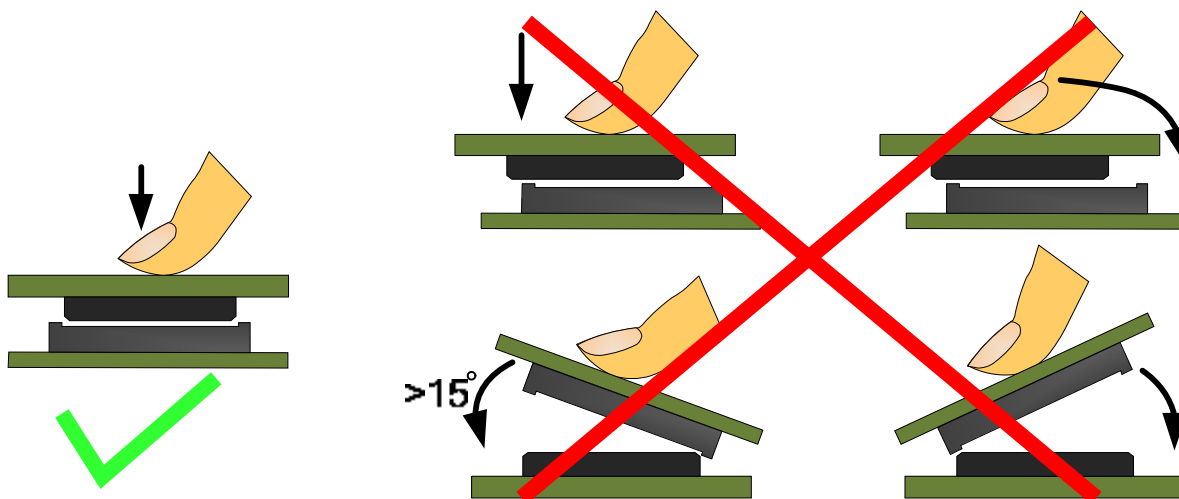

**Precaution for soldering the LCM**

	<b>Manual soldering</b>	<b>Machine drag soldering</b>	<b>Machine press soldering</b>
<b>No RoHS product</b>	290°C ~350°C. Time : 3-5S.	330°C ~350°C. Speed : 4-8 mm/s.	300°C ~330°C. Time : 3-6S. Press: 0.8~1.2Mpa
<b>RoHS product</b>	340°C ~370°C. Time : 3-5S.	350°C ~370°C. Time : 4-8 mm/s.	330°C ~360°C. Time : 3-6S. Press: 0.8~1.2Mpa

- 1) If soldering flux is used, be sure to remove any remaining flux after finishing to soldering operation. (This does not apply in the case of a non-halogen type of flux.) It is recommended that you protect the LCD surface with a cover during soldering to prevent any damage due to flux spatters.
- 2) When soldering the electroluminescent panel and PC board, the panel and board should not be detached more than three times. This maximum number is determined by the temperature and time conditions mentioned above, though there may be some variance depending on the temperature of the soldering iron.
- 3) When remove the electroluminescent panel from the PC board, be sure the solder has completely melted, the soldered pad on the PC board could be damaged.

**Precautions for Operation**

- 1) Viewing angle varies with the change of liquid crystal driving voltage (VLCD). Adjust VLCD to show the best contrast.
- 2) It is an indispensable condition to drive LCD's within the specified voltage limit since the higher voltage then the limit cause the shorter LCD life. An electrochemical reaction due to direct current causes LCD's undesirable deterioration, so that the use of direct current drive should be avoided.
- 3) Response time will be extremely delayed at lower temperature than the operating temperature range and on the other hand at higher temperature LCD's show dark color in them. However those phenomena do not mean malfunction or out of order with LCD's, Which will come back in the specified operating temperature.
- 4) If the display area is pushed hard during operation, the display will become abnormal. However, it will return to normal if it is turned off and then back on.
- 5) A slight dew depositing on terminals is a cause for electro-chemical reaction resulting in terminal open circuit. Usage under the maximum operating temperature, 50%RH or less is required.
- 6) Input logic voltage before apply analog high voltage such as LCD driving voltage when power on. Remove analog high voltage before logic voltage when power off the module. Input each signal after the positive/negative voltage becomes stable.
- 7) Please keep the temperature within specified range for use and storage. Polarization degradation, bubble generation or polarizer peel-off may occur with high temperature and high humidity.

**Safety**

- 1) It is recommended to crush damaged or unnecessary LCDs into pieces and wash them off with solvents such as acetone and ethanol, which should later be burned.
- 2) If any liquid leaks out of a damaged glass cell and comes in contact with the hands, wash off thoroughly with soap and water.

**Limited Warranty**

Unless agreed between TRULY and customer, TRULY will replace or repair any of its LCD modules which are found to be functionally defective when inspected in accordance with TRULY LCD acceptance standards (copies available upon request) for a period of one year from date of production. Cosmetic/visual defects must be returned to TRULY within 90 days of shipment. Confirmation of such date shall be based on data code on product. The warranty liability of TRULY limited to repair and/or replacement on the terms set forth above. TRULY will not be responsible for any subsequent or consequential events.

**Return LCM under warranty**

No warranty can be granted if the precautions stated above have been disregarded. The typical examples of violations are :

- Broken LCD glass.
- PCB eyelet is damaged or modified.
- PCB conductors damaged.
- Circuit modified in any way, including addition of components.
- PCB tampered with by grinding, engraving or painting varnish.
- Soldering to or modifying the bezel in any manner.

Module repairs will be invoiced to the customer upon mutual agreement. Modules must be returned with sufficient

description of the failures or defects. Any connectors or cable installed by the customer must be removed completely without damaging the PCB eyelet, conductors and terminals.

## ■ PRIOR CONSULT MATTER

1. ①For Truly standard products, we keep the right to change material, process ... for improving the product property without notice on our customer.  
②For OEM products, if any change needed which may affect the product property, we will consult with our customer in advance.
2. If you have special requirement about reliability condition, please let us know before you start the test on our samples.

## ■ FACTORY CONTACT INFORMATION

**FACTORY NAME:** TRULY SEMICONDUCTORS LTD.

**FACTORY ADDRESS:** Truly Industrial Area, ShanWei City,GuangDong,China

**P.C:** 516600 **URL:** <http://www.truly.com.hk> <http://www.trulysemi.com>