

**PRODUCT** : LCD MODULE

---

**MODEL NO.** : TFT240320-272-E

---

**SUPPLIER** : TRULY SEMICONDUCTORS LTD.

---

**DATE** : September 24, 2010

---



CERT. No. QAC0946535  
(ISO9001)



CERT. No. HKG002005  
(ISO14001)

# SPECIFICATION

Revision: 1.0

**TFT240320-272-E**

This module uses ROHS material

If there is no special request from the customer, TRULY SEMICONDUCTORS LTD. will not reserve the tooling of the product under the following conditions:

1. There is no response from the customer in two years after TRULY SEMICONDUCTORS LTD. submit the samples.
2. There is no order in two years after the latest mass production.

And correlated data (including quality records) will be reserved for one year more after tooling is discarded.

**TRULY SEMICONDUCTORS LTD:**

**CUSTOMER:**

Quality Assurance Department: \_\_\_\_\_

Approved by: \_\_\_\_\_

Technical Department: \_\_\_\_\_

Approved by:



## CONTENTS

- GENERAL INFORMATION
- EXTERNAL DIMENSIONS
- ABSOLUTE MAXIMUM RATINGS
- ELECTRICAL CHARACTERISTICS
- BACKLIGHT CHARACTERISTICS
- ELECTRO-OPTICAL CHARACTERISTICS
- INTERFACE DESCRIPTION
- REFERENCE APPLICATION CIRCUIT
- RELIABILITY TEST CONDITIONS
- INSPECTION CRITERION
- PRECAUTIONS FOR USING LCD MODULES
- PACKING SPECIFICATION
- PRIOR CONSULT MATTER
- FACTORY CONTACT INFORMATION

<b>WRITTEN BY</b>	<b>CHECKED BY</b>	<b>APPROVED BY</b>
HUANG YAN XUE	ZHAN JUN BIN	ZHANG SHU HANG

**■ GENERAL INFORMATION**

<b>Item of general information</b>	<b>Contents</b>	<b>Unit</b>
LCD type	TFT/TRANSMISSIVE	/
Recommended Viewing Direction	12:00	O' Clock
Module area (W × H × T)	57.54×79.20×3.65	mm <sup>3</sup>
Viewing area (W×H)	50.6×66.8	mm <sup>2</sup>
Active area (W×H)	48.6×64.8	mm <sup>2</sup>
Number of Dots	240(RGB)×320	/
Pixel pitch (W × H)	0.2025×0.2025	mm <sup>2</sup>
Driver IC	R61505W	/
Interface Type	MPU/SPI+RGB	/
Input voltage	2.8	V
Module Power consumption	298	mw
Colors	262K	/
Backlight Type	LED	/



**■ ABSOLUTE MAXIMUM RATINGS**

Parameter of absolute maximum ratings	Symbol	Min	Max	Unit
Supply voltage for logic	VCC/IOVCC	-0.3	4.6	V
Input voltage	VIN	-0.3	IOVCC+0.3	V
Operating temperature	Top	-20	70	°C
Storage temperature	TST	-30	80	°C
Humidity	RH	-	90%(Max60 °C)	RH

**■ ELECTRICAL CHARACTERISTICS****DC CHARACTERISTICS**

Parameter of DC characteristics	Symbol	Min	Typ	Max	Unit
Supply voltage for logic	VCC	2.5	2.8	3.3	V
I/O power supply	IOVCC	1.65	1.8/2.8	3.3	V
Input Current	Icc	-	10.42	20.84	mA
Input voltage 'H' level	VIH	0.8IOVCC	-	IOVCC	V
Input voltage 'L' level	VIL	-0.3	-	0.2IOVCC	V
Output voltage 'H' level	VOH	0.8IOVCC	-	-	V
Output voltage 'L' level	VOL	-	-	0.2IOVCC	V

**■ BACKLIGHT CHARACTERISTICS**

Item of backlight characteristics	Symbol	Min.	Typ.	Max.	Unit	Condition
Forward voltage	Vf	15	16	17	V	If=15mA Ta=25°C
Luminance	Lv	1200	1500	1800	cd/m <sup>2</sup>	
Number of LED	-	-	5	-	Piece	-
Connection mode	S	-	Serial	-	-	-

Using condition: constant current driving method If=15mA(+/-10%).

■ ELECTRO-OPTICAL CHARACTERISTICS

Item of electro-optical characteristics	Symbol	Condition	Min	Typ	Max	Unit	Remark	Note
Response time	Tr+ Tf	θ=0° ∅=0° Ta=25°C	-	30	45	ms	Fig.1	4
Contrast ratio	Cr		300	701	-	---	FIG 2.	1
Luminance uniformity	δ WHITE		78	87	-	%	FIG 2.	3
Surface Luminance	Lv		268	335	-	cd/m <sup>2</sup>	FIG 2.	2
Viewing angle range	θ	∅ = 90°	51	61	-	deg	FIG 3.	6
		∅ = 270°	70	80	-	deg	FIG 3.	
		∅ = 0°	70	80	-	deg	FIG 3.	
		∅ = 180°	70	80	-	deg	FIG 3.	

Note1. Contrast Ratio(CR) is defined mathematically by the following formula. For more information see FIG 2.:

$$\text{ContrastRatio} = \frac{\text{AverageSurface Luminance with all white pixels (P 1, P2, P 3, P4, P5)}}{\text{Average SurfaceLuminance with all black pixels (P1, P2, P 3, P4, P5)}}$$

Note2. Surface luminance is the LCD surface from the surface with all pixels displaying white. For more information see FIG 2.

$$Lv = \text{Average Surface Luminance with all white pixels (P1, P2, P 3, P4, P5)}$$

Note3. The uniformity in surface luminance (δ WHITE) is determined by measuring luminance at each test position 1 through 5, and then dividing the maximum luminance of 5 points luminance by minimum luminance of 5 points luminance. For more information see FIG 2.

$$\delta \text{ WHITE} = \frac{\text{Minimum Surface Luminance with all white pixels (P}_1, \text{P}_2, \text{P}_3, \text{P}_4, \text{P}_5)}{\text{Maximum Surface Luminance with allwhite pixels (P}_1, \text{P}_2, \text{P}_3, \text{P}_4, \text{P}_5)}$$

Note4. Response time is the time required for the display to transition from White to black(Rise Time, Tr) and from black to white(Decay Time, Tf). For additional information see FIG 1..

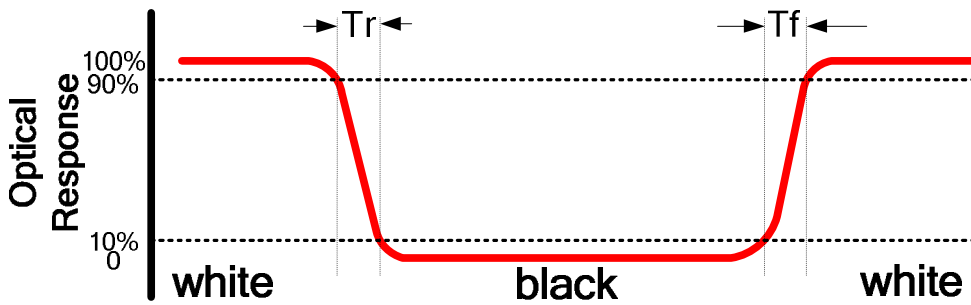
Note5. CIE (x, y) chromaticity ,The x,y value is determined by screen active area position 5. For more information see FIG 2.

Note6. Viewing angle is the angle at which the contrast ratio is greater than 2. For TFT module the contrast ratio is greater than 10. The angles are determined for the horizontal or x axis and the vertical or y axis with respect to the z axis which is normal to the LCD surface. For more information see FIG 3.

Note7. For Viewing angle and response time testing, the testing data is base on Autronic-Melchers's ConoScope. Series Instruments. For contrast ratio, Surface Luminance, Luminance uniformity and CIE, the testing data is base on TOPCON's BM-5 photo detector.

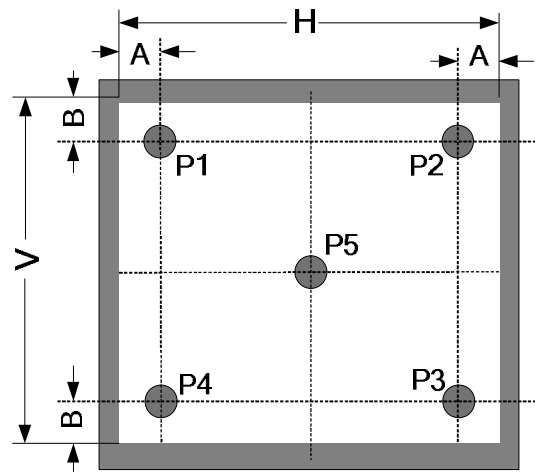
Note8. For TFT transmissive module, Gray scale reverse occurs in the direction of panel viewing angle.

**FIG.1. The definition of Response Time**

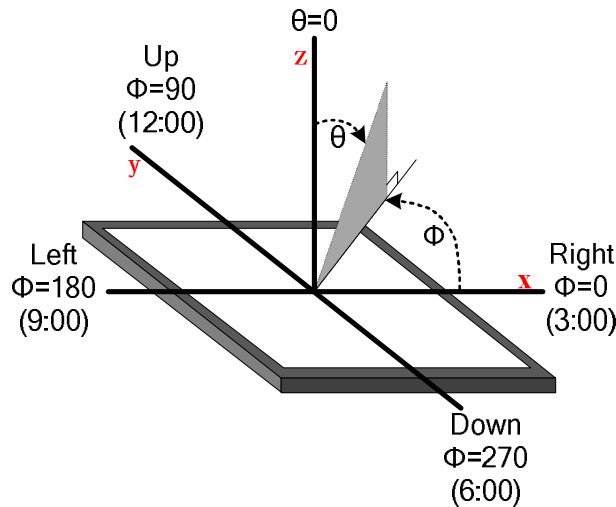


**FIG.2. Measuring method for Contrast ratio, surface luminance, Luminance uniformity, CIE (x, y) chromaticity**

A : 5 mm  
 B : 5 mm  
 H, V : Active Area  
 Light spot size  $\varnothing=5\text{mm}$ , 500mm distance from the LCD surface to detector lens  
 measurement instrument is TOPCON's luminance meter BM-5



**FIG.3. The definition of viewing angle**



**■ INTERFACE DESCRIPTION**

Pin NO.	NAME	I/O or connect to	DESCRIPTION	When not in use																																						
1	LEDK	LED driver	LED ( CATHODE )	-																																						
2	LEDK	LED driver	LED ( CATHODE )	-																																						
3	LEDA	LED driver	LED ANODE	-																																						
4	LEDA	LED driver	LED ANODE	-																																						
5	IM0	I Host processor	<table border="1"> <thead> <tr> <th>IM3</th> <th>IM2</th> <th>IM1</th> <th>IM0</th> <th>System interface</th> <th>DB pins</th> </tr> </thead> <tbody> <tr> <td>0</td> <td>0</td> <td>1</td> <td>0</td> <td>80-system 16-bit interface</td> <td>DB17-10, DB8-1</td> </tr> <tr> <td>0</td> <td>0</td> <td>1</td> <td>1</td> <td>80-system 8-bit interface</td> <td>DB17-10</td> </tr> <tr> <td>0</td> <td>1</td> <td>0</td> <td>0</td> <td>Clock synchronous serial interface</td> <td>(SDI, SDO)</td> </tr> <tr> <td>1</td> <td>0</td> <td>1</td> <td>0</td> <td>80-system 18-bit interface</td> <td>DB17-0</td> </tr> <tr> <td>8</td> <td>IM3</td> <td></td> <td>1</td> <td>0</td> <td>1</td> <td>80-system 9-bit interface</td> <td>DB17-9</td> </tr> </tbody> </table>	IM3	IM2	IM1	IM0	System interface	DB pins	0	0	1	0	80-system 16-bit interface	DB17-10, DB8-1	0	0	1	1	80-system 8-bit interface	DB17-10	0	1	0	0	Clock synchronous serial interface	(SDI, SDO)	1	0	1	0	80-system 18-bit interface	DB17-0	8	IM3		1	0	1	80-system 9-bit interface	DB17-9	-
IM3	IM2		IM1	IM0	System interface	DB pins																																				
0	0		1	0	80-system 16-bit interface	DB17-10, DB8-1																																				
0	0		1	1	80-system 8-bit interface	DB17-10																																				
0	1		0	0	Clock synchronous serial interface	(SDI, SDO)																																				
1	0	1	0	80-system 18-bit interface	DB17-0																																					
8	IM3		1	0	1	80-system 9-bit interface	DB17-9																																			
9	FMARK	O Host processor	Frame head pulse signal, which is used when writing data to the internal RAM. (Amplitude: IOVCC-GND).	Open																																						
10	VSYNC	I Host processor	Frame synchronous signal for RGB interface operation. Low active. (Amplitude: IOVCC-GND).	GND or IOVCC																																						
11	HSYNC	I Host processor	Line synchronous signal for RGB interface operation. Low active. (Amplitude: IOVCC-GND).	GND or IOVCC																																						
12	DOTCLK	I Host processor	Dot clock signal for RGB interface operation. The data input timing is on the rising edge of DOTCLK. (Amplitude: IOVCC-GND).	GND or IOVCC																																						
13	ENABLE	I Host processor	Data enable signal for RGB interface operation. (Amplitude: IOVCC-GND). Low: accessible (select) High: Not accessible (Not select) The polarity of ENABLE signal can be inverted by setting the EPL bit.(Amplitude: IOVCC-GND).	GND or IOVCC																																						
14	DB17	I/O Host processor	18-bit parallel bi-directional data bus for 80-system interface operation (Amplitude: IOVCC-GND). 8-bit I/F: DB17-DB10 are used. 9-bit I/F: DB17-DB9 are used. 16-bit I/F: DB17-DB10 and DB8-1 are used. 18-bit I/F: DB17-DB0 are used. 18-bit parallel bi-directional data bus for RGB interface operation (Amplitude: IOVCC-GND). 16-bit I/F: DB17-DB13 and DB11-1 are used. 18-bit I/F: DB17-DB0 are used.	-																																						
15	DB16																																									
16	DB15																																									
17	DB14																																									
18	DB13																																									
19	DB12																																									
20	DB11																																									
21	DB10																																									
22	DB9																																									
23	DB8																																									
24	DB7																																									
25	DB6																																									

26	DB5	I/O Host processor	18-bit parallel bi-directional data bus for 80-system interface operation (Amplitude: IOVCC-GND).	-
27	DB4		8-bit I/F: DB17-DB10 are used.	
28	DB3		9-bit I/F: DB17-DB9 are used.	
29	DB2		16-bit I/F: DB17-DB10 and DB8-1 are used.	
30	DB1		18-bit I/F: DB17-DB0 are used.	
31	DB0		18-bit parallel bi-directional data bus for RGB interface operation (Amplitude: IOVCC-GND).	
32	IOVCC	Power supply	Power supply to the interface pins: RESETX, CSX, WRX, RDX, RS,DB17-0, VSYNC, HSYNC, DOTCLK, ENABLE. 1.65V ~ 3.3V	-
33	CS	I Host processor	Chip select signal. Amplitude: IOVCC-GND Low: the chip is selected and accessible High: the chip is not selected and not accessible.	IOVCC
34	RS	I Host processor	Register select signal. Amplitude: IOVCC-GND Low: select Index register High: select control register	IOVCC
35	WR/SCL	I Host processor	Write strobe signal in 80-system bus interface operation and enables write operation when WRX is low. Synchronous clock signal (SCL) in serial interface operation. Amplitude: IOVCC-GND	IOVCC
36	RD	I Host processor	Read strobe signal in 80-system bus interface operation and enables read operation when RDX is low. Amplitude: IOVCC-GND	IOVCC
37	RESET	I Host processor or external circuit	Reset signal. The chip is initialized when this signal is at low level. Make sure to execute a power-on reset when turning on power supply (Amplitude: IOVCC-GND).	-
38	SDI	Host processor	Serial data input (SDI) pin in serial interface operation. The data is inputted on the rising edge of the SCL signal. Amplitude: IOVCCGND	GND or IOVCC
39	VCC	Power supply	Power supply to internal logic regulator circuit.2.5V ~ 3.3V	-
40	GND	Power supply	System GND	-

**■ REFERENCE APPLICATION CIRCUIT**

Please consult our technical department for detail information.

**■ RELIABILITY TEST CONDITIONS**

No.	Test Item	Test Condition	Inspection after test
1	High Temperature Storage	80±2℃/200 hours	Inspection after 2~4hours storage at room temperature, the sample shall be free from defects: 1.Air bubble in the LCD; 2.Sealleak; 3.Non-display; 4.missing segments; 5.Glass crack; 6.Current Idd is twice higher than initial value.
2	Low Temperature Storage	-30±2℃/200 hours	
3	High Temperature Operating	70±2℃/120 hours	
4	Low Temperature Operating	-20±2℃/120 hours	
5	Temperature Cycle	-20±2℃~25~70±2℃×10cycles	
6	Damp Proof Test	50℃±5℃×90%RH/120 hours	
7	Vibration Test	Frequency: 10Hz~55Hz~10Hz Amplitude: 1.5mm, X, Y, Z direction for total 3hours (Packing condition)	
8	Dropping test	Drop to the ground from 1m height, one time, every side of carton. (Packing condition)	
9	ESD test	Voltage:±8KV R: 330Ω C: 150pF Air discharge, 10time	

**Remark:**

- 1.The test samples should be applied to only one test item.
- 2.Sample size for each test item is 5~10pcs.
- 3.For Damp Proof Test, Pure water(Resistance>10MΩ) should be used.
- 4.In case of malfunction defect caused by ESD damage, if it would be recovered to normal state after resetting, it would be judged as a good part.
- 5.EL evaluation should be excepted from reliability test with humidity and temperature: Some defects such as black spot/blemish can happen by natural chemical reaction with humidity and Fluorescence EL has.
- 6.Failure Judgment Criterion: Basic Specification, Electrical Characteristic, Mechanical Characteristic, Optical Characteristic.

**■ INSPECTION CRITERION**

<b>TRULY</b> <sup>®</sup> OUTGOING QUALITY STANDARD	PAGE 1 OF 4
TITLE:FUNCTIONAL TEST & INSPECTION CRITERIA	MDS Product
<p>This specification is made to be used as the standard acceptance/rejection criteria for Color mobile phone LCM.</p> <p>1 Sample plan</p> <p>Sampling plan according to GB/T2828.1-2003/ISO 2859-1: 1999 and ANSI/ASQC Z1.4-1993, normal level 2 and based on:</p> <p>Major defect: AQL 0.65</p> <p>Minor defect: AQL 1.5</p> <p>2. Inspection condition</p> <p>Viewing distance for cosmetic inspection is about 30cm with bare eyes, and under an environment of 20~40W light intensity, all directions for inspecting the sample should be within 45°against perpendicular line.</p> <p>3. Definition of inspection zone in LCD.</p> <div data-bbox="526 1066 1013 1285" data-label="Diagram"> </div> <p>Zone A: character/Digit area</p> <p>Zone B: viewing area except Zone A (ZoneA+ZoneB=minimum Viewing area)</p> <p>Zone C: Outside viewing area (invisible area after assembly in customer's product)</p> <p>Fig.1 Inspection zones in an LCD.</p> <p>Note: As a general rule, visual defects in Zone C are permissible, when it is no trouble for quality and assembly of customer's product.</p>	

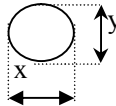
<b>TRULY</b> <sup>®</sup> OUTGOING QUALITY STANDARD	PAGE 2 OF 4
TITLE:FUNCTIONAL TEST & INSPECTION CRITERIA	MDS Product

**4. Inspection standards**

**4.1 Major Defect**

Item No	Items to be inspected	Inspection Standard	Classification of defects
4.1.1	All functional defects	1) No display 2) Display abnormally 3) Missing vertical, horizontal segment 4) Short circuit 5) Back-light no lighting, flickering and abnormal lighting.	Major
4.1.2	Missing	Missing component	
4.1.3	Outline dimension	Overall outline dimension beyond the drawing is not allowed.	

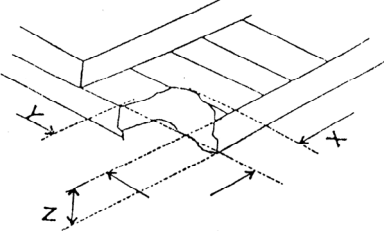
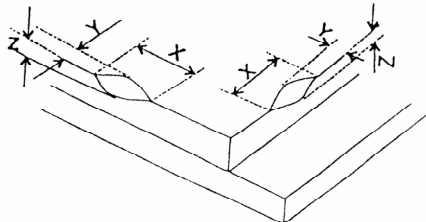
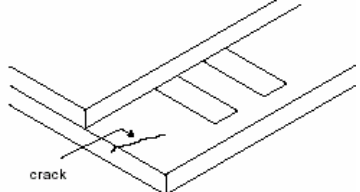
**4.2 Cosmetic Defect**

Item No	Items to be inspected	Inspection Standard	Classification of defects																											
4.2.1	Clear Spots	For dark/white spot, size $\Phi$ is defined as $\Phi = \frac{(x+y)}{2}$ 	Minor																											
	Black and white Spot defect Pinhole, Foreign Particle, Dirt under polarizer	1. <table border="1" style="width: 100%; border-collapse: collapse;"> <thead> <tr> <th rowspan="2">Zone Size(mm)</th> <th colspan="3">Acceptable Qty</th> </tr> <tr> <th>A</th> <th>B</th> <th>C</th> </tr> </thead> <tbody> <tr> <td><math>\Phi \leq 0.10</math></td> <td colspan="3" style="text-align: center;">Ignore</td> </tr> <tr> <td><math>0.10 &lt; \Phi \leq 0.15</math></td> <td colspan="3" style="text-align: center;">2</td> </tr> <tr> <td><math>0.15 &lt; \Phi \leq 0.20</math></td> <td colspan="3" style="text-align: center;">1</td> </tr> <tr> <td><math>\Phi &gt; 0.20</math></td> <td colspan="3" style="text-align: center;">0</td> </tr> </tbody> </table>		Zone Size(mm)	Acceptable Qty			A	B	C	$\Phi \leq 0.10$	Ignore			$0.10 < \Phi \leq 0.15$	2			$0.15 < \Phi \leq 0.20$	1			$\Phi > 0.20$	0						
Zone Size(mm)	Acceptable Qty																													
	A	B	C																											
$\Phi \leq 0.10$	Ignore																													
$0.10 < \Phi \leq 0.15$	2																													
$0.15 < \Phi \leq 0.20$	1																													
$\Phi > 0.20$	0																													
	Dim Spots	2. <table border="1" style="width: 100%; border-collapse: collapse;"> <thead> <tr> <th rowspan="2">2. Zone Size(mm)</th> <th colspan="3">Acceptable Qty</th> </tr> <tr> <th>A</th> <th>B</th> <th>C</th> </tr> </thead> <tbody> <tr> <td><math>\Phi \leq 0.2</math></td> <td colspan="3" style="text-align: center;">Ignore</td> </tr> <tr> <td><math>0.20 &lt; \Phi \leq 0.40</math></td> <td colspan="3" style="text-align: center;">3</td> </tr> <tr> <td><math>0.40 &lt; \Phi \leq 0.60</math></td> <td colspan="3" style="text-align: center;">2</td> </tr> <tr> <td><math>0.60 &lt; \Phi \leq 0.80</math></td> <td colspan="3" style="text-align: center;">1</td> </tr> <tr> <td><math>0.80 &lt; \Phi</math></td> <td colspan="3" style="text-align: center;">0</td> </tr> </tbody> </table>	2. Zone Size(mm)	Acceptable Qty			A	B	C	$\Phi \leq 0.2$	Ignore			$0.20 < \Phi \leq 0.40$	3			$0.40 < \Phi \leq 0.60$	2			$0.60 < \Phi \leq 0.80$	1			$0.80 < \Phi$	0			Minor
2. Zone Size(mm)	Acceptable Qty																													
	A	B	C																											
$\Phi \leq 0.2$	Ignore																													
$0.20 < \Phi \leq 0.40$	3																													
$0.40 < \Phi \leq 0.60$	2																													
$0.60 < \Phi \leq 0.80$	1																													
$0.80 < \Phi$	0																													

<b>TRULY</b> ® OUTGOING QUALITY STANDARD	PAGE 3 OF 4
TITLE: FUNCTIONAL TEST & INSPECTION CRITERIA	MDS Product

4.2. Cosmetic Defect

Item No	Items to be inspected	Inspection Standard	Classification of defects																																	
4.2.2	Line defect Black line, White line, Foreign material under polarizer,	<table border="1"> <thead> <tr> <th colspan="2">Size(mm)</th> <th colspan="3">Acceptable Qty</th> </tr> <tr> <th rowspan="2">L(Length)</th> <th rowspan="2">W(Width)</th> <th colspan="3">Zone</th> </tr> <tr> <th>A</th> <th>B</th> <th>C</th> </tr> </thead> <tbody> <tr> <td>Ignore</td> <td><math>W \leq 0.02</math></td> <td colspan="3">Ignore</td> </tr> <tr> <td><math>L \leq 3.0</math></td> <td><math>0.02 &lt; W \leq 0.03</math></td> <td colspan="3">2</td> </tr> <tr> <td><math>L \leq 2.0</math></td> <td><math>0.03 &lt; W \leq 0.05</math></td> <td colspan="3">1</td> </tr> <tr> <td></td> <td><math>0.05 &lt; W</math></td> <td colspan="3">Define as spot defect</td> </tr> </tbody> </table>	Size(mm)		Acceptable Qty			L(Length)	W(Width)	Zone			A	B	C	Ignore	$W \leq 0.02$	Ignore			$L \leq 3.0$	$0.02 < W \leq 0.03$	2			$L \leq 2.0$	$0.03 < W \leq 0.05$	1				$0.05 < W$	Define as spot defect			Minor
Size(mm)		Acceptable Qty																																		
L(Length)	W(Width)	Zone																																		
		A	B	C																																
Ignore	$W \leq 0.02$	Ignore																																		
$L \leq 3.0$	$0.02 < W \leq 0.03$	2																																		
$L \leq 2.0$	$0.03 < W \leq 0.05$	1																																		
	$0.05 < W$	Define as spot defect																																		
4.2.3	Polarizer scratch	<p>If the Polarizer scratch can be seen after mobile phone cover assembling or in the operating condition, judge by the line defect of 4.2.2.</p> <p>If the Polarizer scratch can be seen only in non-operating condition or some special angle, judge by the following.</p> <table border="1"> <thead> <tr> <th colspan="2">Size(mm)</th> <th colspan="3">Acceptable Qty</th> </tr> <tr> <th rowspan="2">L(Length)</th> <th rowspan="2">W(Width)</th> <th colspan="3">Zone</th> </tr> <tr> <th>A</th> <th>B</th> <th>C</th> </tr> </thead> <tbody> <tr> <td>Ignore</td> <td><math>W \leq 0.03</math></td> <td colspan="3">Ignore</td> </tr> <tr> <td><math>5.0 &lt; L \leq 10.0</math></td> <td><math>0.03 &lt; W \leq 0.05</math></td> <td colspan="3">2</td> </tr> <tr> <td><math>L \leq 5.0</math></td> <td><math>0.05 &lt; W \leq 0.08</math></td> <td colspan="3">1</td> </tr> <tr> <td></td> <td><math>0.08 &lt; W</math></td> <td colspan="3">0</td> </tr> </tbody> </table>	Size(mm)		Acceptable Qty			L(Length)	W(Width)	Zone			A	B	C	Ignore	$W \leq 0.03$	Ignore			$5.0 < L \leq 10.0$	$0.03 < W \leq 0.05$	2			$L \leq 5.0$	$0.05 < W \leq 0.08$	1				$0.08 < W$	0			Minor
Size(mm)		Acceptable Qty																																		
L(Length)	W(Width)	Zone																																		
		A	B	C																																
Ignore	$W \leq 0.03$	Ignore																																		
$5.0 < L \leq 10.0$	$0.03 < W \leq 0.05$	2																																		
$L \leq 5.0$	$0.05 < W \leq 0.08$	1																																		
	$0.08 < W$	0																																		
4.2.4	Polarize Air bubble	<p>Air bubbles between glass &amp; polarizer</p> <table border="1"> <thead> <tr> <th rowspan="2">2. Zone Size(mm)</th> <th colspan="3">Acceptable Qty</th> </tr> <tr> <th>A</th> <th>B</th> <th>C</th> </tr> </thead> <tbody> <tr> <td><math>\Phi \leq 0.2</math></td> <td colspan="3">Ignore</td> </tr> <tr> <td><math>0.20 &lt; \Phi \leq 0.30</math></td> <td colspan="3">2</td> </tr> <tr> <td><math>0.30 &lt; \Phi \leq 0.50</math></td> <td colspan="3">1</td> </tr> <tr> <td><math>0.50 &lt; \Phi</math></td> <td colspan="3">0</td> </tr> </tbody> </table>	2. Zone Size(mm)	Acceptable Qty			A	B	C	$\Phi \leq 0.2$	Ignore			$0.20 < \Phi \leq 0.30$	2			$0.30 < \Phi \leq 0.50$	1			$0.50 < \Phi$	0			Minor										
2. Zone Size(mm)	Acceptable Qty																																			
	A	B	C																																	
$\Phi \leq 0.2$	Ignore																																			
$0.20 < \Phi \leq 0.30$	2																																			
$0.30 < \Phi \leq 0.50$	1																																			
$0.50 < \Phi$	0																																			

<b>TRULY®</b> OUTGOING QUALITY STANDARD		PAGE 4 OF 4							
TITLE:FUNCTIONAL TEST & INSPECTION CRITERIA		MDS Product							
4.3. Cosmetic Defect									
Item No	Items to be inspected	Inspection Standard	Classification of defects						
4.3.5	Glass defect	(i) Chips on corner  <table border="1" data-bbox="516 703 1112 787"> <tr> <td>X</td> <td>Y</td> <td>Z</td> </tr> <tr> <td>≤2.0</td> <td>≤S</td> <td>Disregard</td> </tr> </table> <p>Notes: S=contact pad length Chips on the corner of terminal shall not be allowed to extend into the ITO pad or expose perimeter seal.</p>	X	Y	Z	≤2.0	≤S	Disregard	Minor
		X	Y	Z					
		≤2.0	≤S	Disregard					
(ii) Usual surface cracks  <table border="1" data-bbox="495 1186 1128 1270"> <tr> <td>X</td> <td>Y</td> <td>Z</td> </tr> <tr> <td>≤3.0</td> <td>&lt;Inner border line of the seal</td> <td>Disregard</td> </tr> </table>	X	Y	Z	≤3.0	<Inner border line of the seal	Disregard	Minor		
X	Y	Z							
≤3.0	<Inner border line of the seal	Disregard							
(iii) Crack Cracks tend to break are not allowed. 	Major								
4.3.6	Parts alignment	1) Not allow IC and FPC/heat-seal lead width is more than 50% beyond lead pattern. 2) Not allow chip or solder component is off center more than 50% of the pad outline.	Minor						
4.3.7	SMT	According to the <Acceptability of electronic assemblies> IPC-A-610C class 2 standard. Component missing or function defect are Major defect, the others are Minor defect.							

## ■ PRECAUTIONS FOR USING LCD MODULES

### 1 Handling Precautions

- 1.1 The display panel is made of glass and polarizer. As glass is fragile. It tends to become or chipped during handling especially on the edges. Please avoid dropping or jarring. Do not subject it to a mechanical shock by dropping it or impact.
- 1.2 If the display panel is damaged and the liquid crystal substance leaks out, be sure not to get any in your mouth. If the substance contacts your skin or clothes, wash it off using soap and water.
- 1.3 Do not apply excessive force to the display surface or the adjoining areas since this may cause the color tone to vary. Do not touch the display with bare hands. This will stain the display area and degraded insulation between terminals (some cosmetics are determined to the polarizer).
- 1.4 The polarizer covering the display surface of the LCD module is soft and easily scratched. Handle this polarizer carefully. Do not touch, push or rub the exposed polarizers with anything harder than an HB pencil lead (glass, tweezers, etc.). Do not put or attach anything on the display area to avoid leaving marks on it. Condensation on the surface and contact with terminals due to cold will damage, stain or dirty the polarizer. After products are tested at low temperature they must be warmed up in a container before coming in to contact with room temperature air.
- 1.5 If the display surface becomes contaminated, breathe on the surface and gently wipe it with a soft dry cloth. If it is heavily contaminated, moisten cloth with one of the following solvents
  - Isopropyl alcohol
  - Ethyl alcoholDo not scrub hard to avoid damaging the display surface.
- 1.6 Solvents other than those above-mentioned may damage the polarizer. Especially, do not use the following.
  - Water
  - Ketone
  - Aromatic solventsWipe off saliva or water drops immediately, contact with water over a long period of time may cause deformation or color fading. Avoid contact with oil and fats.
- 1.7 Exercise care to minimize corrosion of the electrode. Corrosion of the electrodes is accelerated by water droplets, moisture condensation or a current flow in a high-humidity environment.
- 1.8 Install the LCD Module by using the mounting holes. When mounting the LCD module make sure it is free of twisting, warping and distortion. In particular, do not forcibly pull or bend the I/O cable or the backlight cable.
- 1.9 Do not attempt to disassemble or process the LCD module.
- 1.10 NC terminal should be open. Do not connect anything.
- 1.11 If the logic circuit power is off, do not apply the input signals.
- 1.12 Electro-Static Discharge Control, Since this module uses a CMOS LSI, the same careful attention should be paid to electrostatic discharge as for an ordinary CMOS IC. To prevent destruction of the elements by static electricity, be careful to maintain an optimum work environment.
  - Before removing LCM from its packing case or incorporating it into a set, be sure the module and your body have the same electric potential. Be sure to ground the body when handling the LCD modules.
  - Tools required for assembling, such as soldering irons, must be properly grounded. Make certain the AC power source for the soldering iron does not leak. When using an electric screwdriver to attach LCM, the screwdriver should be of ground potentiality to minimize as much as possible any transmission of electromagnetic waves produced sparks coming from the commutator of the motor.
  - To reduce the amount of static electricity generated, do not conduct assembling

and other work under dry conditions. To reduce the generation of static electricity be careful that the air in the work is not too dry. A relative humidity of 50%-60% is recommended. As far as possible make the electric potential of your work clothes and that of the work bench the ground potential.

- The LCD module is coated with a film to protect the display surface. Exercise care when peeling off this protective film since static electricity may be generated.

1.13 Since LCM has been assembled and adjusted with a high degree of precision, avoid applying excessive shocks to the module or making any alterations or modifications to it.

- Do not alter, modify or change the shape of the tab on the metal frame.

- Do not make extra holes on the printed circuit board, modify its shape or change the positions of components to be attached.

- Do not damage or modify the pattern writing on the printed circuit board.

- Absolutely do not modify the zebra rubber strip (conductive rubber) or heat seal connector.

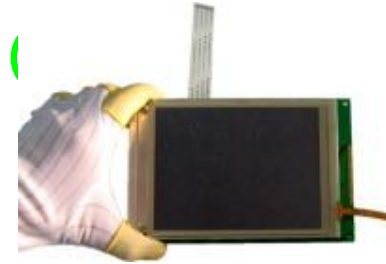
- Except for soldering the interface, do not make any alterations or modifications with a soldering iron.

- Do not drop, bend or twist the LCM.

**2 Handling precaution for LCM**

**2.1 LCM is easy to be damaged. Please note below and be careful for handling.**

**2.2 Correct handling:**

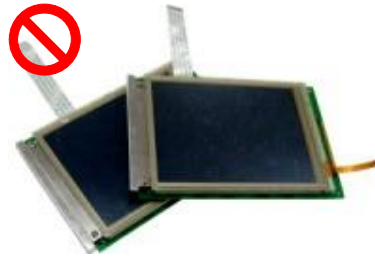


As above picture, please handle with anti-static gloves around LCM edges.

**2.3 Incorrect handling:**



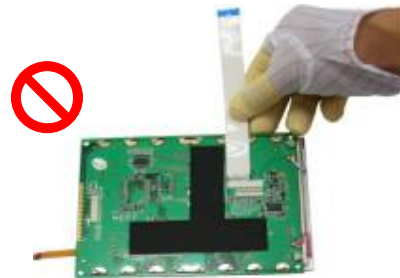
Please don't touch IC directly.



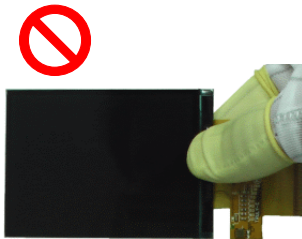
Please don't stack LCM.



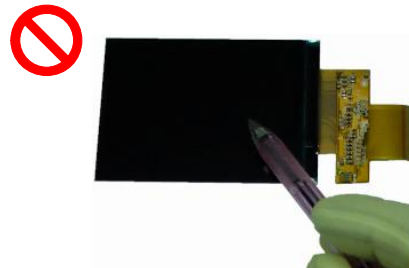
Please don't hold the surface of panel.



Please don't stretch interface of output, such as FPC cable.



Please don't hold the surface of IC.



Please don't operate with sharp stick such as pens.

### 3 Storage Precautions

3.1 When storing the LCD modules, the following precaution are necessary.

- 3.1.1 Store them in a sealed polyethylene bag. If properly sealed, there is no need for the desiccant.
- 3.1.2 Store them in a dark place. Do not expose to sunlight or fluorescent light, keep the temperature between 0°C and 35°C, and keep the relative humidity between 40%RH and 60%RH.
- 3.1.3 The polarizer surface should not come in contact with any other objects (We advise you to store them in the anti-static electricity container in which they were shipped).

### 3.2 Others 其它

- 3.2.1 Liquid crystals solidify under low temperature (below the storage temperature range) leading to defective orientation or the generation of air bubbles (black or white). Air bubbles may also be generated if the module is subject to a low temperature.
- 3.2.2 If the LCD modules have been operating for a long time showing the same display patterns, the display patterns may remain on the screen as ghost images and a slight contrast irregularity may also appear. A normal operating status can be regained by suspending use for some time. It should be noted that this phenomenon does not adversely affect performance reliability.
- 3.2.3 To minimize the performance degradation of the LCD modules resulting from destruction caused by static electricity etc., exercise care to avoid holding the following sections when handling the modules.
  - 3.2.3.1 - Exposed area of the printed circuit board.
  - 3.2.3.2 - Terminal electrode sections.

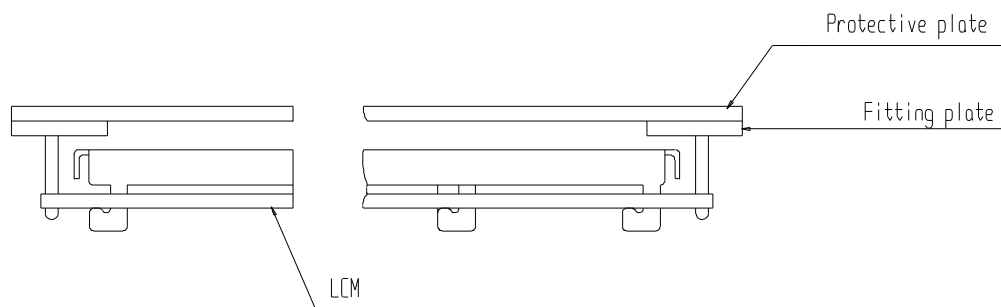
## 4 USING LCD MODULES

### 4.1 Installing LCD Modules

The hole in the printed circuit board is used to fix LCM as shown in the picture below.

Attend to the following items when installing the LCM.

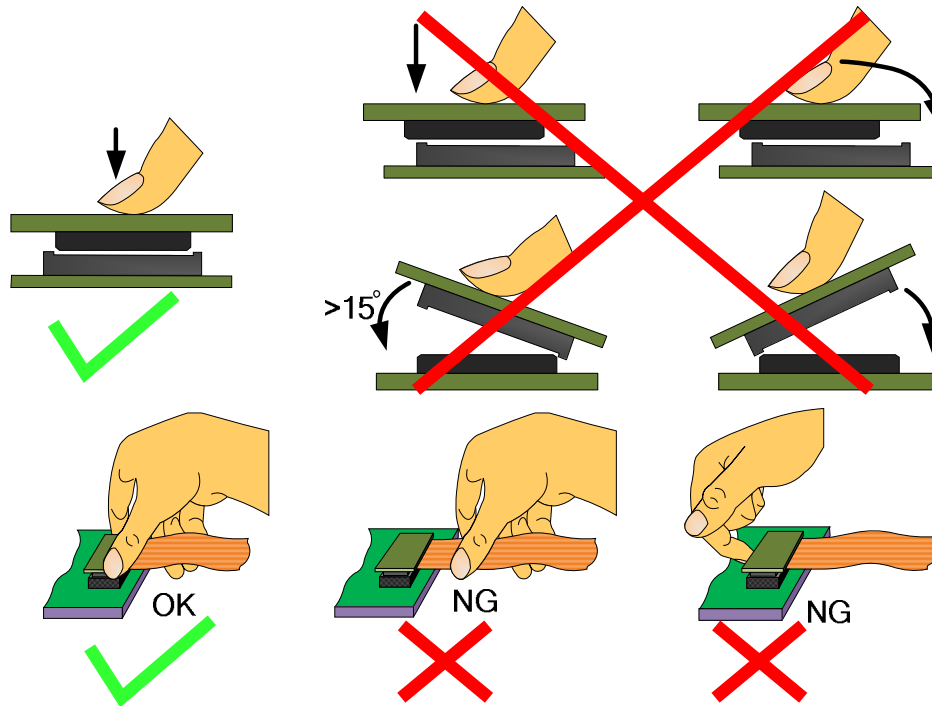
4.1.1 Cover the surface with a transparent protective plate to protect the polarizer and LC cell.



4.1.2 When assembling the LCM into other equipment, the spacer to the bit between the LCM and the fitting plate should have enough height to avoid causing stress to the module surface, refer to the individual specifications for measurements. The measurement tolerance should be  $\pm 0.1$  mm.

4.2 Precaution for assemble the module with BTB connector:

Please note the position of the male and female connector position, don't assemble or assemble like the method which the following picture shows



### 4.3 Precaution for soldering the LCM

	Manual soldering	Machine drag soldering	Machine press soldering
No RoHS Product	290°C ~350°C. Time : 3-5S.	330°C ~350°C. Speed : 15-17 mm/s.	300°C ~330°C. Time : 3-6S. Press: 0.8~1.2Mpa
RoHS Product	340°C ~370°C. Time : 3-5S.	350°C ~370°C. Speed : 15-17 mm/s.	330°C ~360°C. Time : 3-6S. Press: 0.8~1.2Mpa

- 4.3.1 If soldering flux is used, be sure to remove any remaining flux after finishing to soldering operation (This does not apply in the case of a non-halogen type of flux). It is recommended that you protect the LCD surface with a cover during soldering to prevent any damage due to flux spatters.
- 4.3.2 When soldering the electroluminescent panel and PC board, the panel and board should not be detached more than three times. This maximum number is determined by the temperature and time conditions mentioned above, though there may be some variance depending on the temperature of the soldering iron.
- 4.3.3 When remove the electroluminescent panel from the PC board, be sure the solder has completely melted, the soldered pad on the PC board could be damaged.

### 4.4 Precautions for Operation

- 4.4.1 Viewing angle varies with the change of liquid crystal driving voltage (VLCD). Adjust VLCD to show the best contrast.
- 4.4.2 It is an indispensable condition to drive LCD's within the specified voltage limit since the higher voltage then the limit cause the shorter LCD life. An electrochemical reaction due to direct current causes LCD's undesirable deterioration, so that the use of direct current drive should be avoided.
- 4.4.3 Response time will be extremely delayed at lower temperature than the operating temperature range and on the other hand at higher temperature LCD's show dark color in them. However those phenomena do not mean malfunction or out of order with LCD's, which will come back in the specified operating temperature.
- 4.4.4 If the display area is pushed hard during operation, the display will become abnormal. However, it will return to normal if it is turned off and then back on.
- 4.4.5 A slight dew depositing on terminals is a cause for electro-chemical reaction resulting in terminal open circuit. Usage under the maximum operating temperature, 50%RH or less is required.
- 4.4.6 Input logic voltage before apply analog high voltage such as LCD driving voltage when power on. Remove analog high voltage before logic voltage when power off the module. Input each signal after the positive/negative voltage becomes stable.
- 4.4.7 Please keep the temperature within the specified range for use and storage. Polarization degradation, bubble generation or polarizer peel-off may occur with high temperature and high humidity.

### 4.5 Safety

- 4.5.1 It is recommended to crush damaged or unnecessary LCDs into pieces and wash them off with solvents such as acetone and ethanol, which should later be burned.
- 4.5.2 If any liquid leaks out of a damaged glass cell and comes in contact with the hands, wash off thoroughly with soap and water.

#### 4.6 Limited Warranty

Unless agreed between TRULY and the customer, TRULY will replace or repair any of its LCD modules which are found to be functionally defective when inspected in accordance with TRULY LCD acceptance standards (copies available upon request) for a period of one year from date of production. Cosmetic/visual defects must be returned to TRULY within 90 days of shipment. Confirmation of such date shall be based on data code on product. The warranty liability of TRULY limited to repair and/or replace on the terms set forth above. TRULY will not be responsible for any subsequent or consequential events.

#### 4.7 Return LCM under warranty

4.7.1 No warranty can be granted if the precautions stated above have been disregarded. The typical examples of violations are :

4.7.1.1 - Broken LCD glass.

4.7.1.2 - PCB eyelet is damaged or modified.

4.7.1.3 -PCB conductors damaged.

4.7.1.4 - Circuit modified in any way, including addition of components.

4.7.1.5 - PCB tampered with by grinding, engraving or painting varnish.

4.7.1.6 - Soldering to or modifying the bezel in any manner.

4.7.2 Module repairs will be invoiced to the customer upon mutual agreement. Modules must be returned with sufficient description of the failures or defects. Any connectors or cable installed by the customer must be removed completely without damaging the PCB eyelet, conductors and terminals.

### ■ PACKING SPECIFICATION

Please consult our technical department for detail information.

### ■ PRIOR CONSULT MATTER

- 1 For Truly standard products, we keep the right to change material, process ... for improving the product property without prior notice to our customer.
- 2 For OEM products, if any changes are needed which may affect the product property, we will consult with our customer in advance.
- 3 If you have special requirement about reliability condition, please let us know before you start the test on our samples.

### ■ FACTORY CONTACT INFORMATION

**FACTORY NAME:** TRULY SEMICONDUCTORS LTD.

**FACTORY ADDRESS:** Truly Industrial Area, ShanWei City,GuangDong,China

**P.C:** 516600 **URL:** <http://www.truly.com.hk> <http://www.trulysemi.com>